

DH-SD6AW220/230 -HNI

2Mp Full HD Network Auto-Tracking IR Wipe PTZ Dome Camera



Features

- Powerful 20x/30x optical zoom
- H.264 & MJPEG Three-stream encoding
- Max 60fps@720P and 30fps@1080P resolution
- Defog, DWDR, Day/Night(ICR), Ultra DNR, EIS, Auto iris, Auto focus
- Support Wipe
- Multiple network monitoring: Web viewer, CMS(DSS/PSS) & DMSS
- Max 240°/s pan speed, 360° endless pan rotation
- Up to 255 presets, 5 auto scan, 8 tour, 5 pattern
- Built-in 7/2 alarm in/out
- Support Auto tracking and IVS
- Support intelligent 3D positioning with DH-SD protocol
- Micro SD memory, IP66
- IR Distance up to 150m

DH-SD6AW220/230 -HNI

Technical Specifications

Model	DH-SD6AW220-HNI	DH-SD6AW230-HNI
Camera		
Image Sensor	1/2.8" Exmor CMOS	
Effective Pixels	1944(H) x 1092(V), 2 Megapixels	
Scanning System	Progressive	
Electronic Shutter Speed	1/1 ~ 1/30,000s	
Min. Illumination	Color: 0.05Lux@F1.6; B/W: 0.005Lux@F1.6	
S/N Ratio	More than 50dB	
Video Output	BNC(1.0Vp-p/75Ω), PAL / NTSC	
Camera Features		
Day/Night	Auto(ICR) / Color / B/W	
Backlight Compensation	BLC / HLC / DWDR (Digital WDR)	
White Balance	Auto, ATW, Indoor, Outdoor, Manual	
Gain Control	Auto / Manual	
Noise Reduction	Ultra DNR (2D/3D)	
Privacy Masking	Up to 24 areas	
Digital Zoom	16x	
Defog	On / Off	
Wipe	Support	
Lens		
Focal Length	4.7mm~94.0mm (20x Optical zoom)	4.3mm~129mm (30x Optical zoom)
Max Aperture	F1.6 ~ F3.5	F1.6 ~ F4.7
Focus Control	Auto / Manual	
Angle of View	H: 55.4° ~ 2.80°	H: 65.1° ~ 2.34°
Close Focus Distance	10mm~ 1000mm	10mm~ 1200mm
PTZ		
Pan/Tilt Range	Pan: 0° ~ 360° endless; Tilt: -10° ~ 90°, auto flip 180°	
Manual Control Speed	Pan: 0.1° ~ 200° /s; Tilt: 0.1° ~ 120° /s	
Preset Speed	Pan: 240° /s; Tilt: 200° /s	
Preset	80(DH-SD), 255(Pelco-P/D)	
PTZ Mode	5 Pattern, 8 Tour, Auto Pan, Auto Scan	
Speed Setup	Human-oriented focal length/ speed adaptation	
Power up Action	Auto restore to previous PTZ and lens status after power failure	
Idle Motion	Activate Preset/ Pan/ Scan/ Tour/ Pattern if there is no command in the specified period	
Time Task	Auto activation of Preset/ Pan/ Scan/ Tour/ Pattern by preset-time	
Protocol	DH-SD (Auto recognition)	
IR Distance	150m (2 near IR LED+ 8 far IR LED)	

DH-SD6AW220/230 -HNI

Video		
Compression	H.264 / MJPEG	
Resolution	1080P(1920×1080) / 720P(1280×720) / D1(704×576/704×480) / CIF (352×288/352×240)	
Frame Rate	Main Stream	1080P (1 ~ 25/30fps) / 720P(1~50/60fps)
	Sub Stream	D1/CIF(1 ~ 25/30fps)
Bit Rate	H.264: 56K ~ 8192Kbps, MJPEG: 56K ~ 20480Kbps	
Audio		
Compression	G.711a / G.711u(32kbps)/ PCM(128kbps)	
Interface	1/1 channel In/Out	
Intelligent Function		
Auto Tracking	Single-scene, multiple-scene, panorama-scene	
IVS	Tripwire, Cross Warning Zone, Perimeter Protection, Loitering Detection, Abandoned Object Detection, Missing Object Detection, Illegal Parking, Fast Moving and etc.	
Tracking Trigger Mode	Manual / Auto (alarm triggered)	
Tracking Trigger Event	Targeting, Zoom, Tracking, Recording, Snapshot, Alarm and etc.	
Network		
Ethernet	RJ-45 (10/100Base-T)	
Protocol	IPv4/ IPv6, HTTP, HTTPS, SSL, TCP/IP, UDP, UPnP, ICMP, IGMP, SNMP, RTSP, RTP, SMTP, NTP, DHCP, DNS, PPPOE, DDNS, FTP, IP Filter, QoS, Bonjour, 802.1x	
ONVIF	ONVIF Profile S	
Max. User Access	20 users	
Smart Phone	iPhone, iPad, Android, Windows Phone	
Auxiliary Interface		
Memory Slot	Micro SD, Max 64GB	
Alarm	7/2 channel In/Out	
General		
Power Supply	AC 24V/3A (±16%)	
Power Consumption	20W, 43W (IR on, Heater on)	
Working Environment	-40°C ~ 70°C / Less than 90% RH	
Ingress Protection	IP66	
Dimensions	Φ252(mm) x 385 (mm)	
Weight	6.75kg	

DH-SD6AW220/230 -HNI

Dimensions (mm)

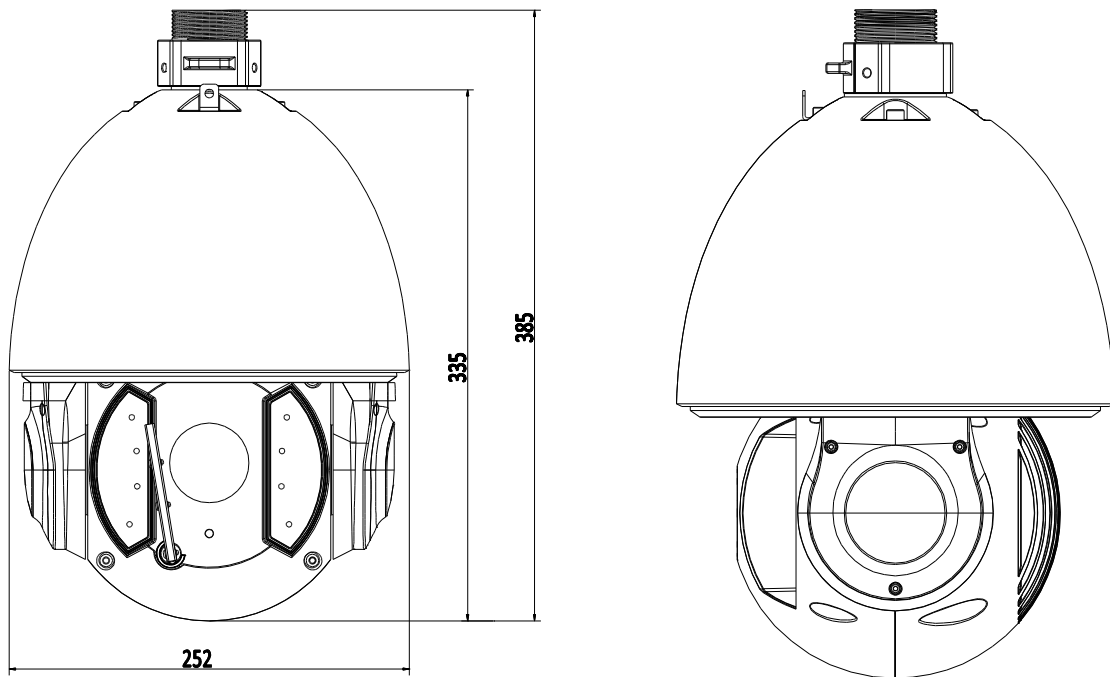







Accessories

		
DH-69FB	DH-PFA111	Power Supply

DH-SD6AW220/230 -HNI

Accessories (Optional)

			
DH-PFB300C	DH- PFB301C	DH-PFA112	DH-PFA113

		
DH- PFA120	DH-PFA150	DH-PFA151

Dahua Technology Co., Ltd.

1199 BinAn Road, Binjiang District, Hangzhou, China

Tel: +86-571-87688883

Fax: +86-571-87688815

Email: overseas@dahuatech.com

www.dahuasecurity.com

*Design and specifications are subject to change without notice.

© 2014 Dahua Technology